

Letter A Wordsearch. Name \_\_\_\_\_

Circle the words that start with A.  
The extra letters make a secret word!

a	a	p	p	l	e	s	a
r	l	l	a	c	o	r	n
r	i	a	r	m	g	a	a
o	a	n	c	h	o	r	p
w	t	o	a	n	t	r	e
a	i	r	p	l	a	n	e

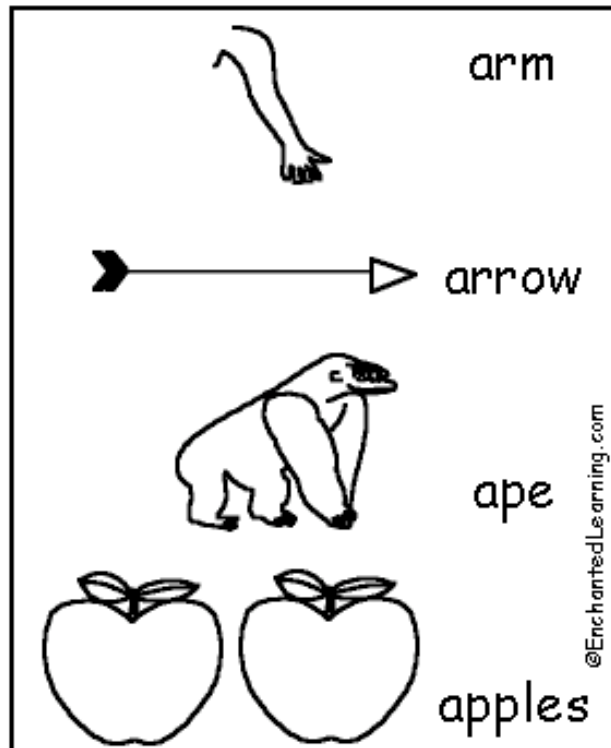
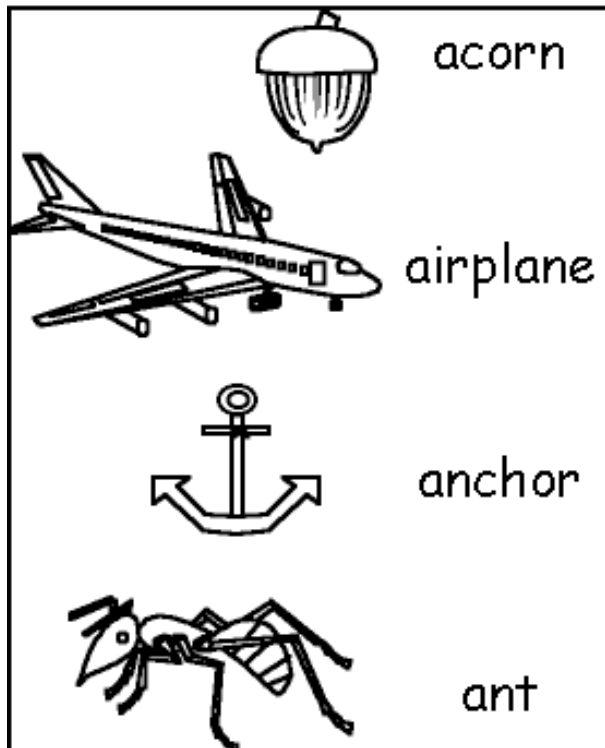

©EnchantedLearning.com

Secret Word:

Letter B Wordsearch. Name \_\_\_\_\_

**Circle the words that start with B.  
The extra letters make a secret word!**

<b>b</b>	<b>b</b>	<b>b</b>	<b>a</b>	<b>n</b>	<b>a</b>	<b>n</b>	<b>a</b>
<b>u</b>	<b>b</b>	<b>i</b>	<b>r</b>	<b>d</b>	<b>u</b>	<b>t</b>	<b>b</b>
<b>t</b>	<b>t</b>	<b>b</b>	<b>a</b>	<b>t</b>	<b>e</b>	<b>r</b>	<b>e</b>
<b>t</b>	<b>f</b>	<b>l</b>	<b>b</b>	<b>u</b>	<b>s</b>	<b>y</b>	<b>e</b>
<b>o</b>	<b>b</b>	<b>a</b>	<b>l</b>	<b>l</b>	<b>o</b>	<b>o</b>	<b>n</b>
<b>n</b>	<b>b</b>	<b>i</b>	<b>c</b>	<b>y</b>	<b>c</b>	<b>l</b>	<b>e</b>

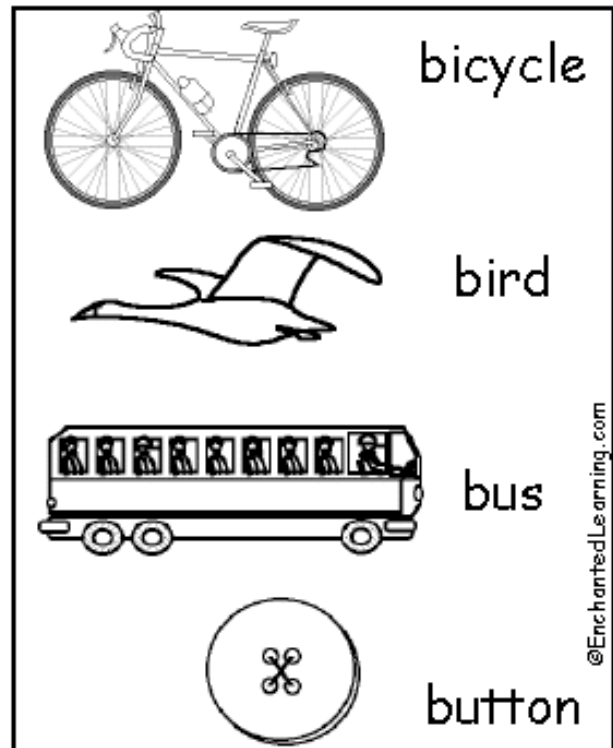
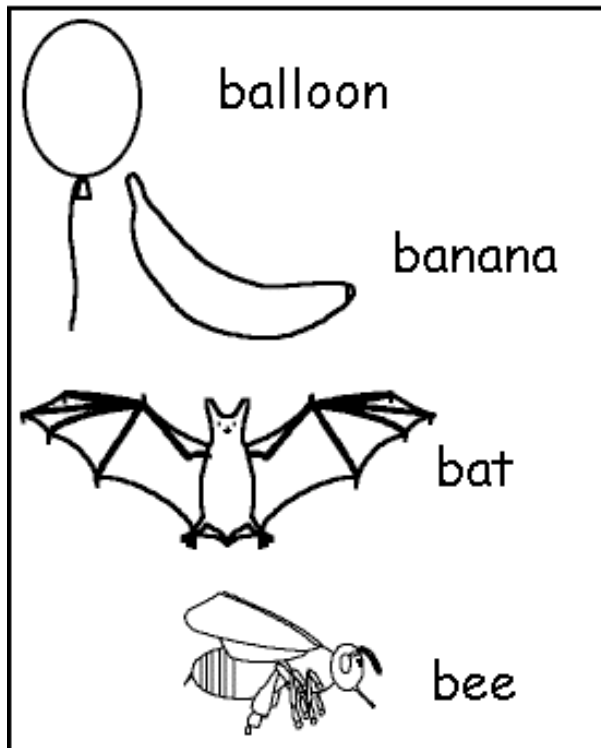

©EnchantedLearning.com

**Secret Word:**

Letter C Wordsearch. Name \_\_\_\_\_

Circle the words that start with C.  
The extra letters make secret words!

c	c	c	a	r	r	o	t
a	c	o	n	e	o	t	c
s	c	t	o	c	u	p	a
t	o	n	c	a	n	d	t
l	r	c	i	r	c	l	e
e	n	y	c	a	m	e	l

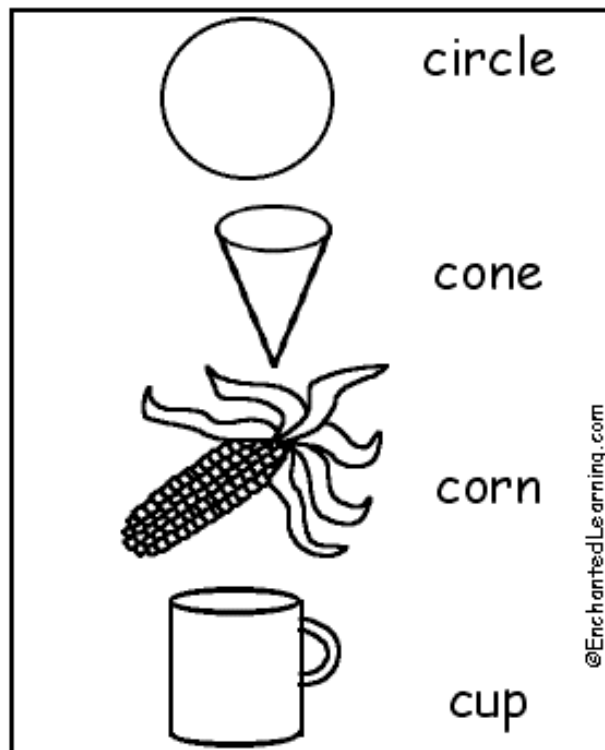
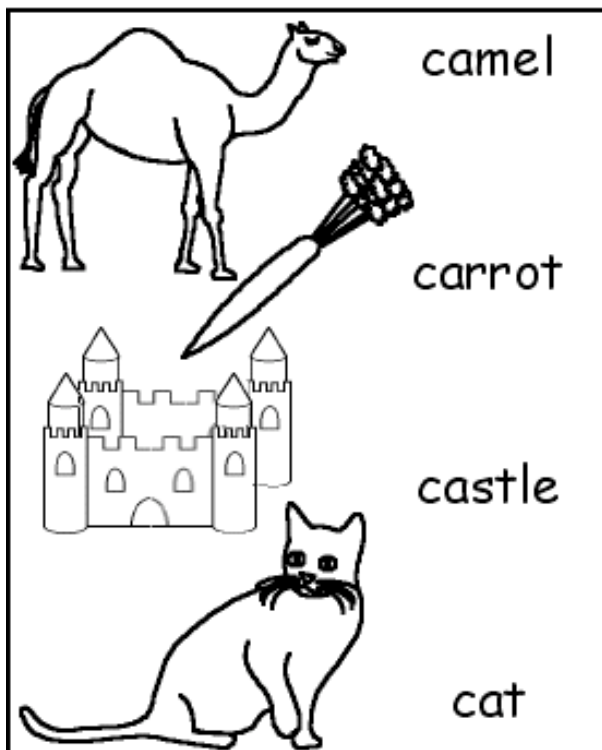





©EnchantedLearning.com



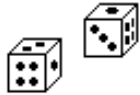

**Secret Words:**

Letter D Wordsearch. Name \_\_\_\_\_

Circle the words that start with D.  
The extra letters make a secret word!

d	d	o	l	p	h	i	n
u	d	r	a	g	o	d	d
c	n	d	e	e	r	o	o
k	d	a	i	s	y	g	l
f	l	y	d	i	c	e	l
d	i	n	o	s	a	u	r

	daisy
	deer
	dice
	dinosaur

	dog
	doll
	dolphin
	duck





©EnchantedLearning.com





**Secret Word:**

Letter E Wordsearch. Name \_\_\_\_\_

Circle the words that start with E.  
The extra letters make a secret word!

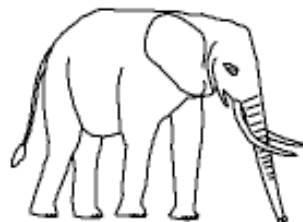
e	l	e	p	h	a	n	t
e	e	e	l	e	v	e	n
a	i	e	e	v	e	e	r
g	g	y	y	t	h	l	e
l	h	i	e	n	g	k	g
e	t	e	a	r	t	h	g

	eagle
	earth
	egg
	eight

	elephant
	eleven
	elk
	eye





©EnchantedLearning.com



**Secret Word:** \_\_\_\_\_

Letter F Wordsearch. Name \_\_\_\_\_

Circle the words that start with F.  
The extra letters make a secret word!

f	e	a	t	h	e	r	f
f	f	e	e	t	f	i	l
o	r	e	f	i	r	e	o
r	f	f	i	s	h	i	w
k	g	f	o	u	r	h	e
f	i	v	e	t	e	r	r

	feather
	feet
	fire
	fish

5	five
	flower
	fork
4	four

©EnchantedLearning.com

**Secret Word:**

Letter G Wordsearch. Name \_\_\_\_\_

Circle the words that start with g.  
The extra letters make a secret word!

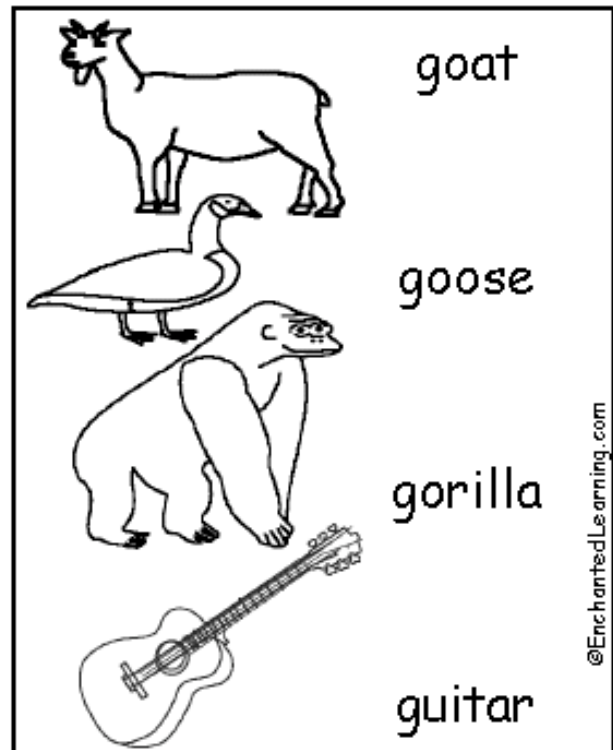
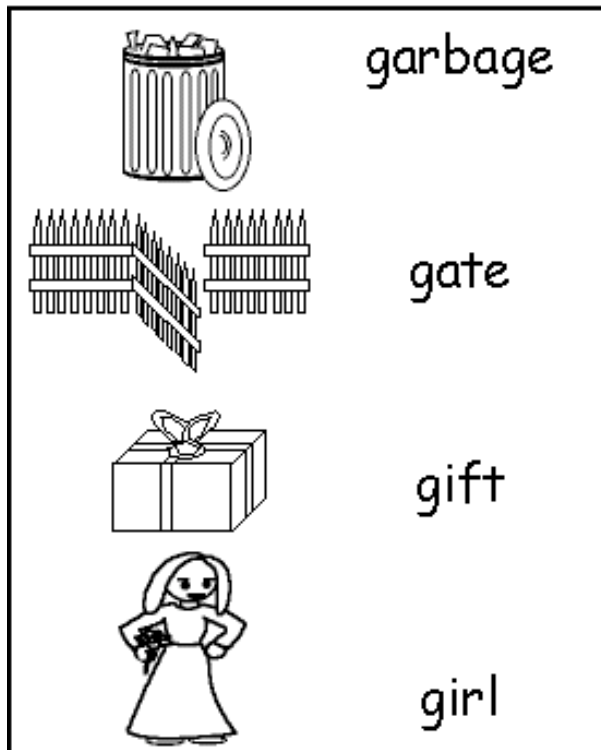
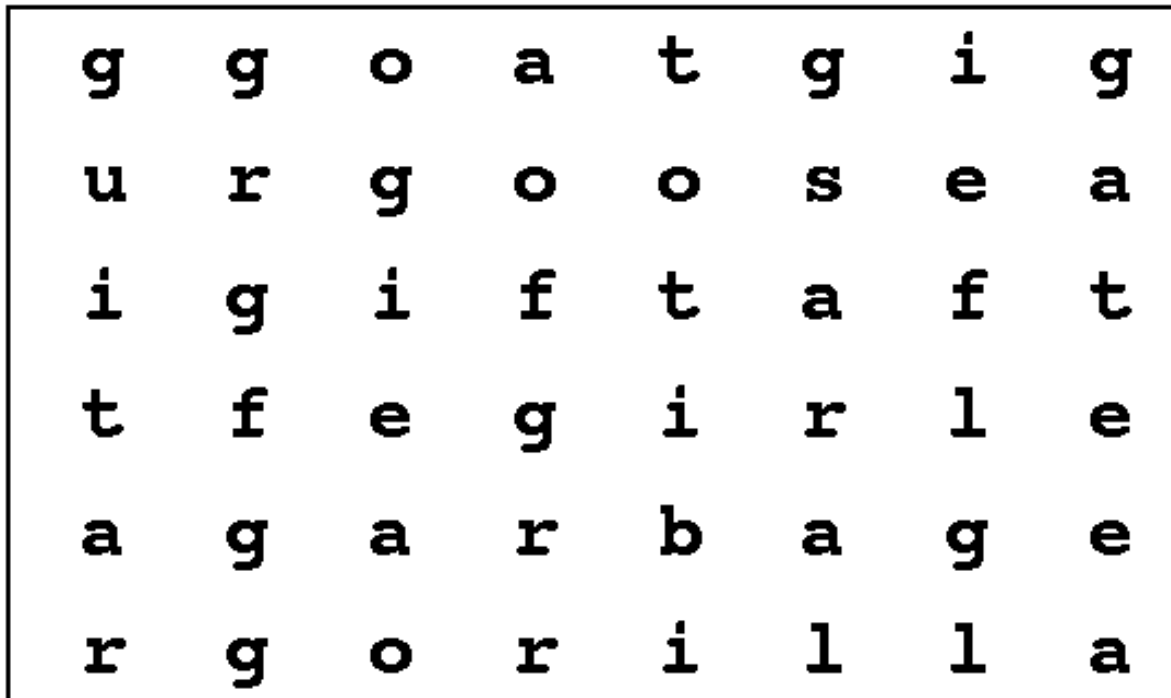





©EnchantedLearning.com



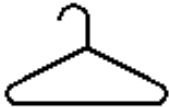

**Secret Word:**

Letter H Wordsearch. Name \_\_\_\_\_

Circle the words that start with H.  
The extra letters make a secret word!

h	h	a	n	g	e	r	h
a	h	h	o	r	s	e	o
m	h	a	n	d	a	i	u
m	r	h	e	n	b	r	s
e	u	s	h	a	t	h	e
r	h	u	n	d	r	e	d

	hammer
	hand
	hanger
	hat

	hen
	horse
	house
	hundred

©EnchantedLearning.com

**Secret Word:** \_\_\_\_\_



Letter I Wordsearch. Name \_\_\_\_\_

**Circle the words that start with I.  
The extra letters make a secret word!**

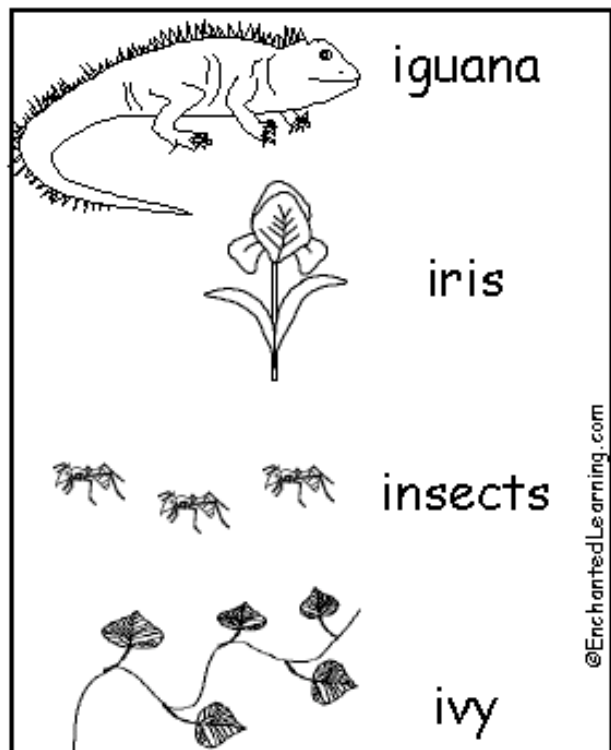
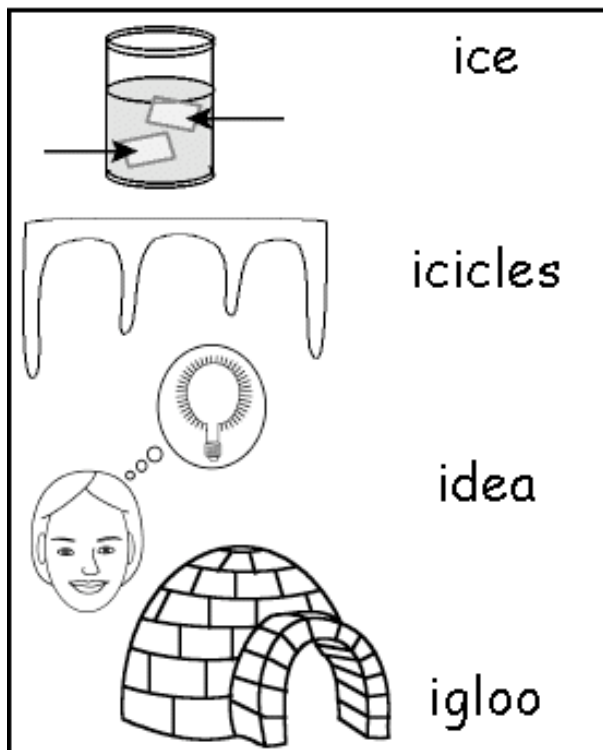
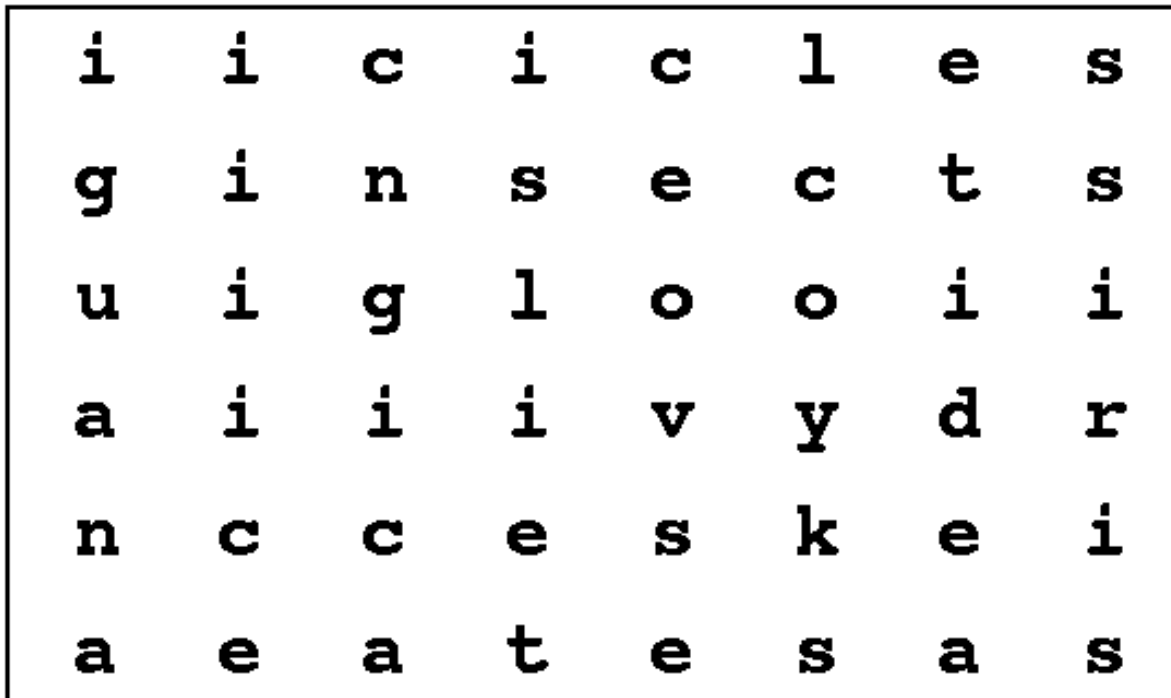





©EnchantedLearning.com

**Secret Word:**

Letter J Wordsearch. Name \_\_\_\_\_

**Circle the words that start with J.  
The extra letters make a secret word!**

j	e	a	n	s	j	j	j
j	j	u	m	p	u	e	a
e	m	p	i	n	g	l	c
t	j	j	a	r	a	l	k
c	j	a	y	k	s	y	e
j	e	w	e	l	r	y	t

	jacket
	jar
	jay
	jeans

	jelly
	jet
	jewelry
	jump

©EnchantedLearning.com

**Secret Word:** \_\_\_\_\_

Letter K Wordsearch. Name \_\_\_\_\_

Circle the words that start with K.  
The extra letters make a secret word!

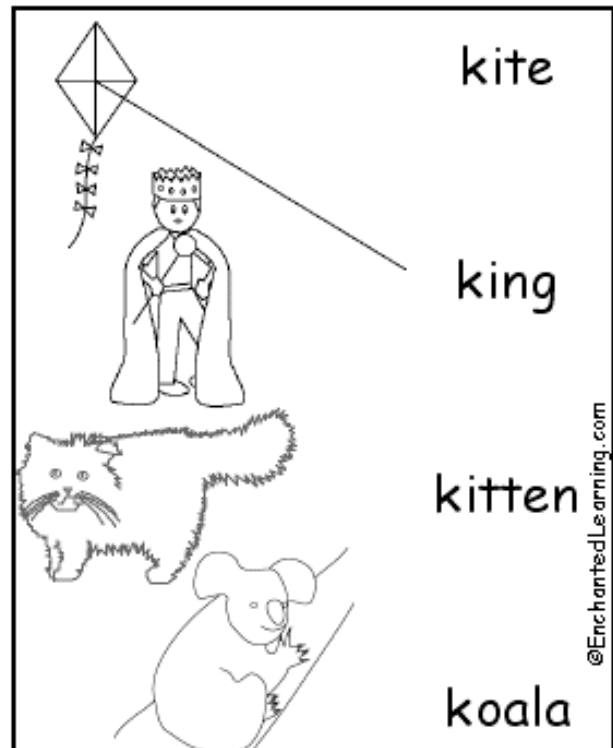
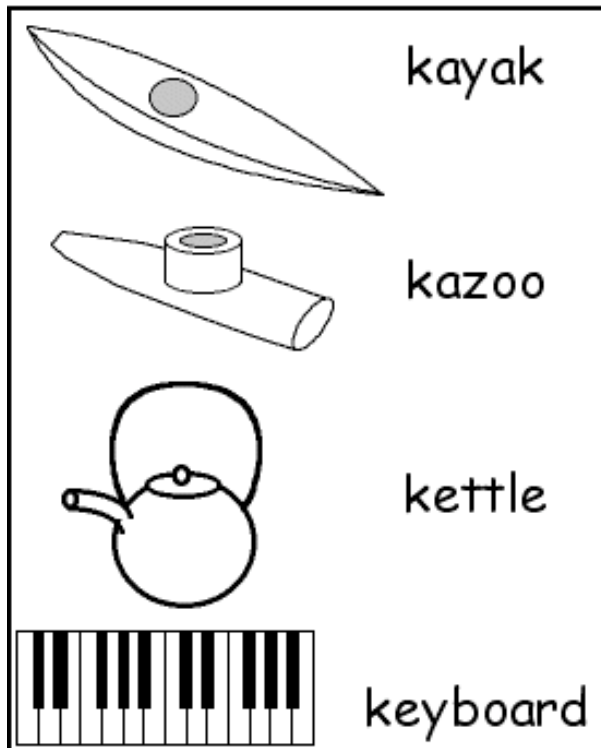
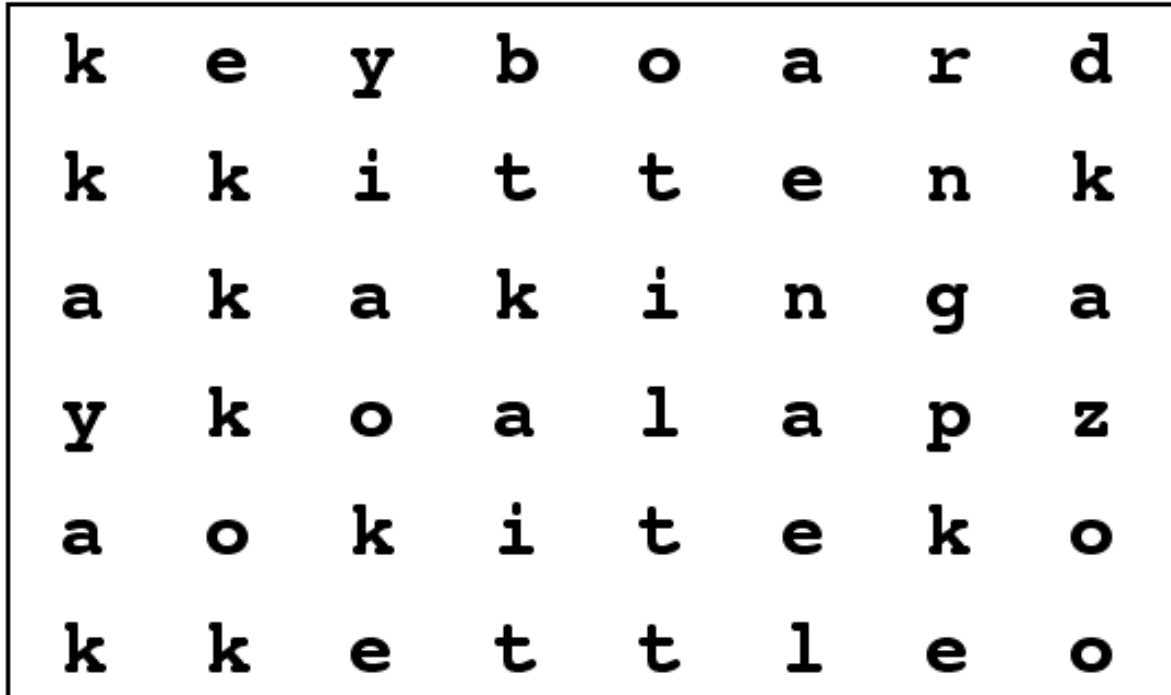

©EnchantedLearning.com

**Secret Word:**

Letter L Wordsearch. Name \_\_\_\_\_

Circle the words that start with L.  
The extra letters make a secret word!

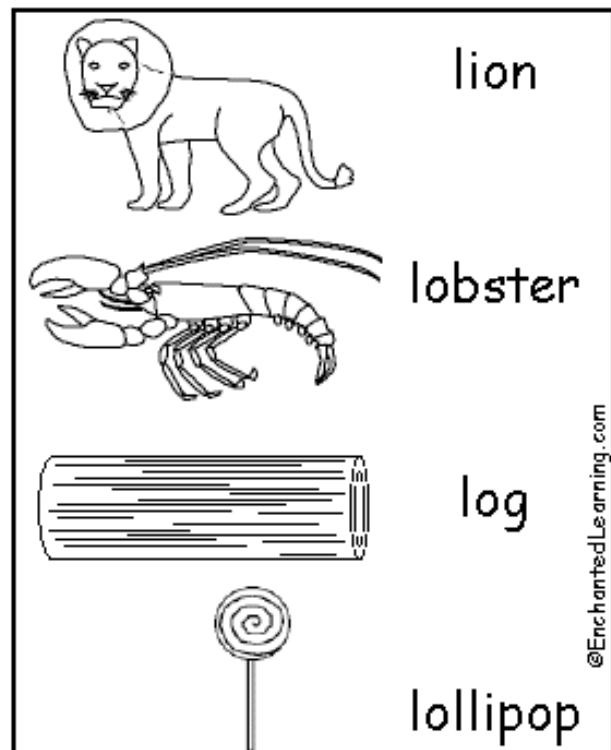
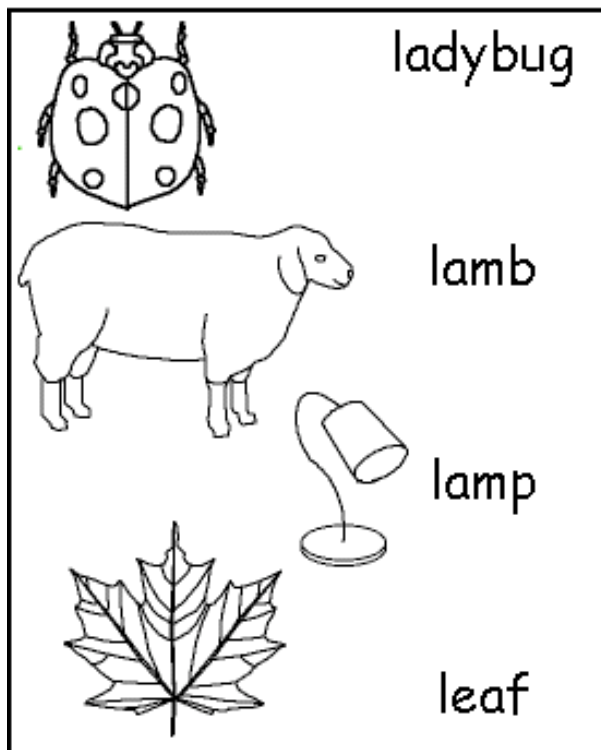
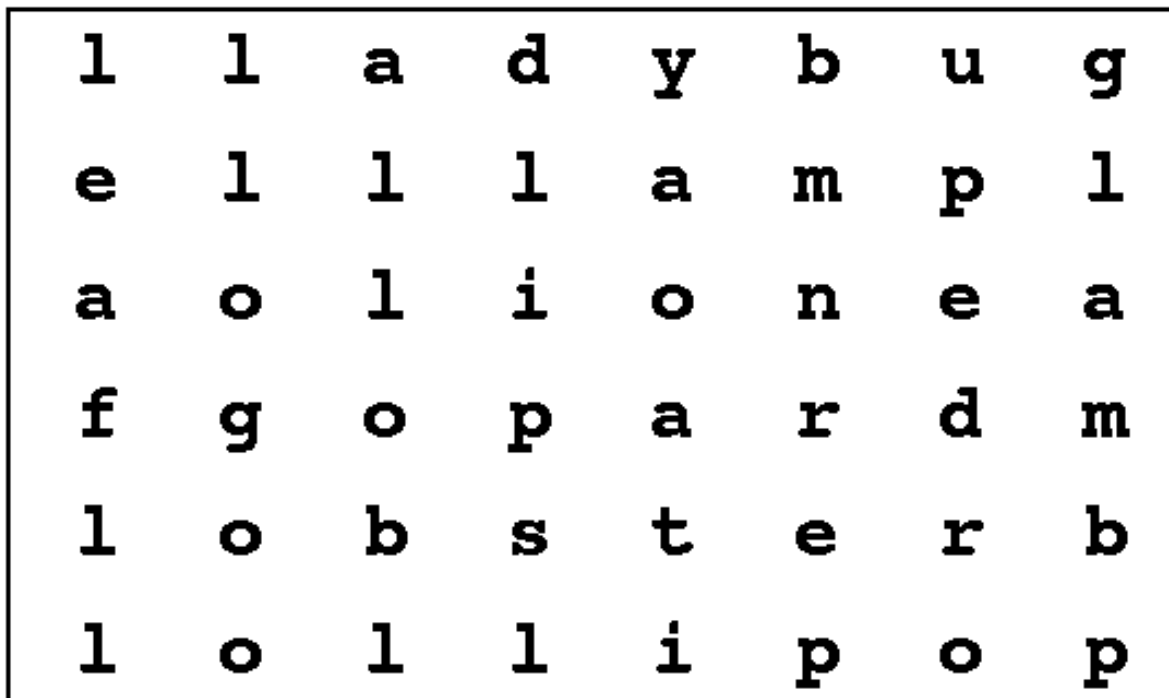

©EnchantedLearning.com

**Secret Word:**

Letter M Wordsearch. Name \_\_\_\_\_

Circle the words that start with M.  
The extra letters make a secret word!

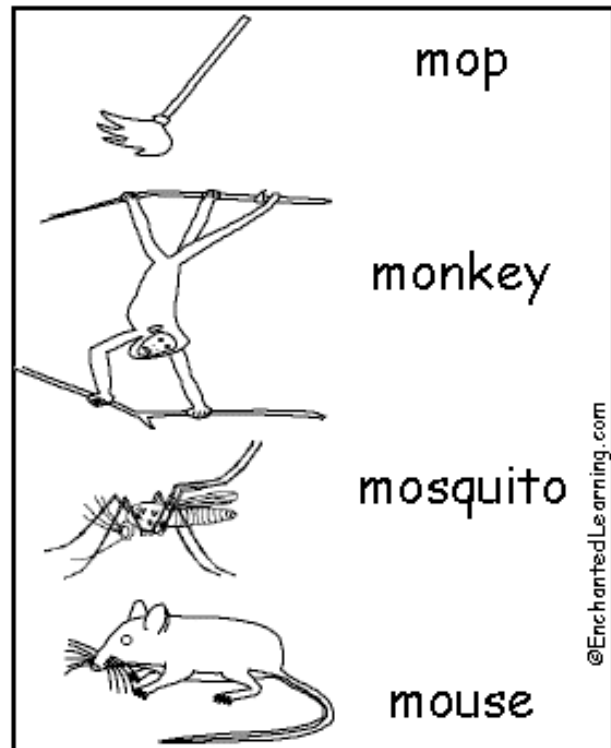
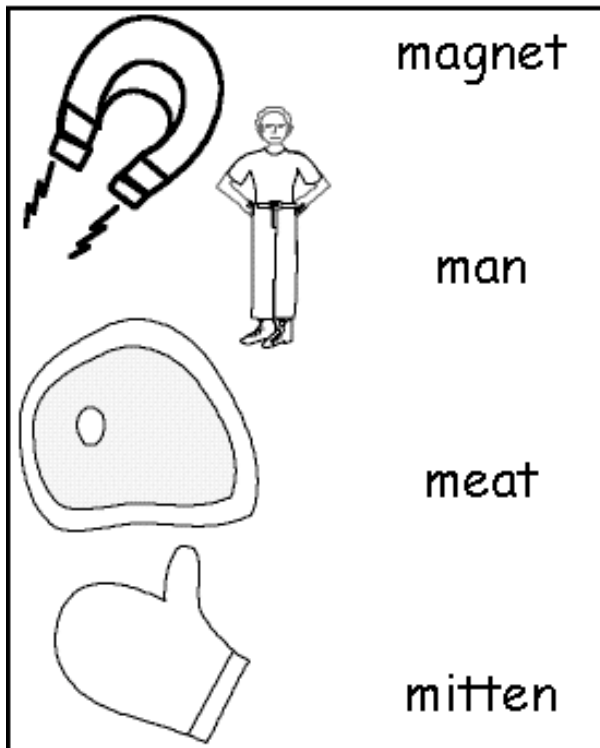
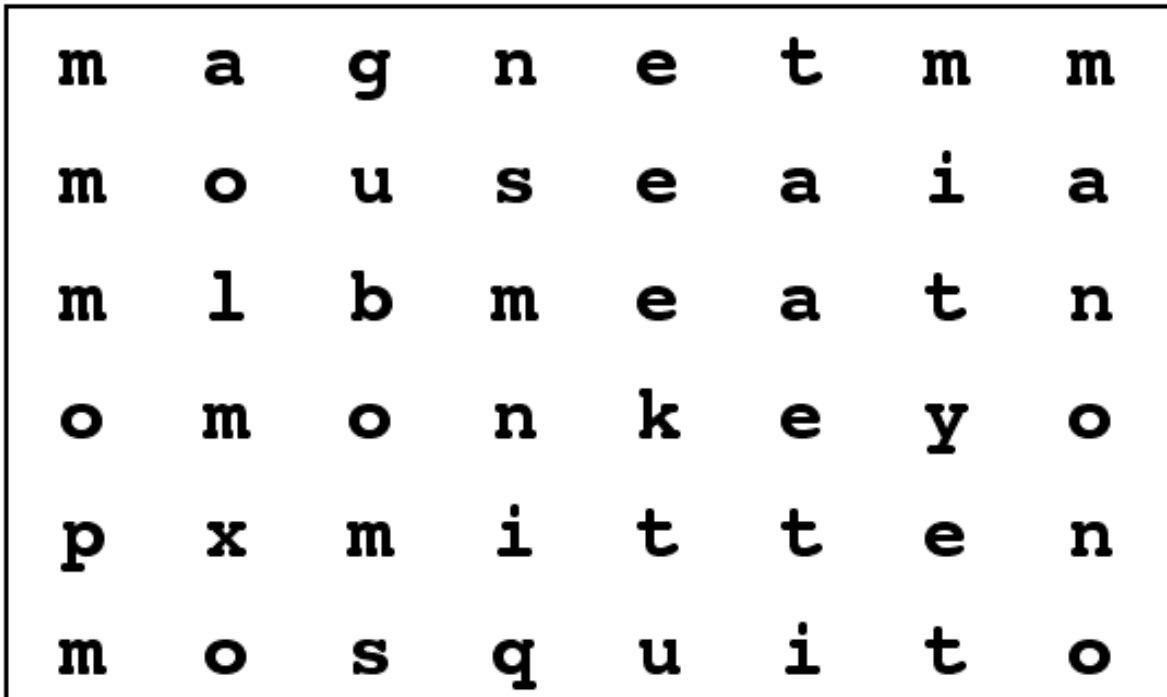



©EnchantedLearning.com



**Secret Word:**

Letter N Wordsearch. Name \_\_\_\_\_

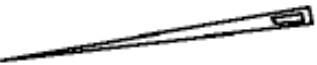
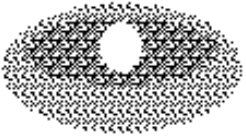
Circle the words that start with N.  
The extra letters make a secret word!

n	o	t	e	b	o	o	k
n	n	o	t	e	s	o	n
n	o	n	e	s	t	d	e
i	n	e	e	d	l	e	t
n	l	e	s	n	a	i	l
e	n	u	m	b	e	r	s

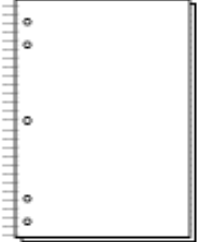
	nail
	needle
	nest
	net

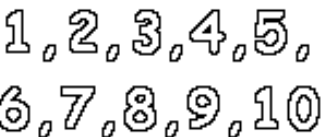
	nine
	notebook
	notes
	numbers

©EnchantedLearning.com

**Secret Word:** \_\_\_\_\_

Letter O Wordsearch. Name \_\_\_\_\_

Circle the words that start with O.  
The extra letters spell two secret words!

o	c	t	o	p	u	s	o
o	o	o	v	a	l	l	n
w	o	r	a	n	g	e	i
l	o	r	c	a	d	o	o
s	a	o	a	r	s	t	n
m	o	b	o	e	e	a	l

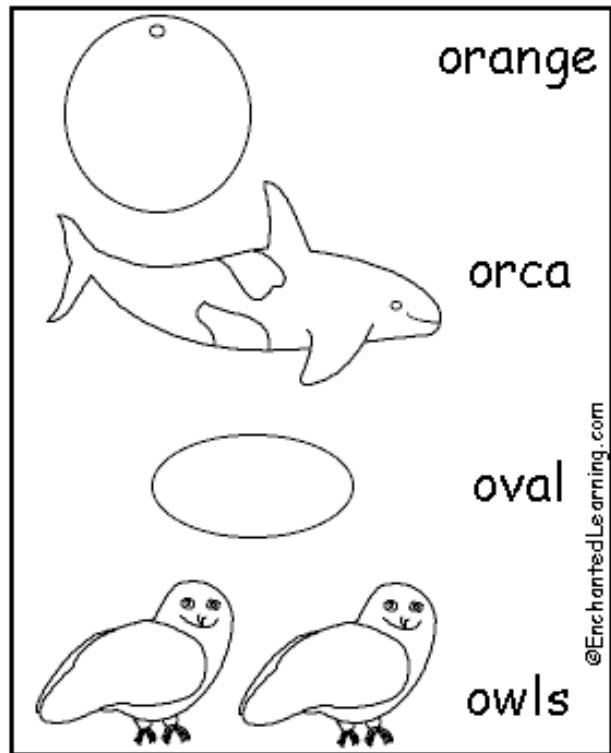
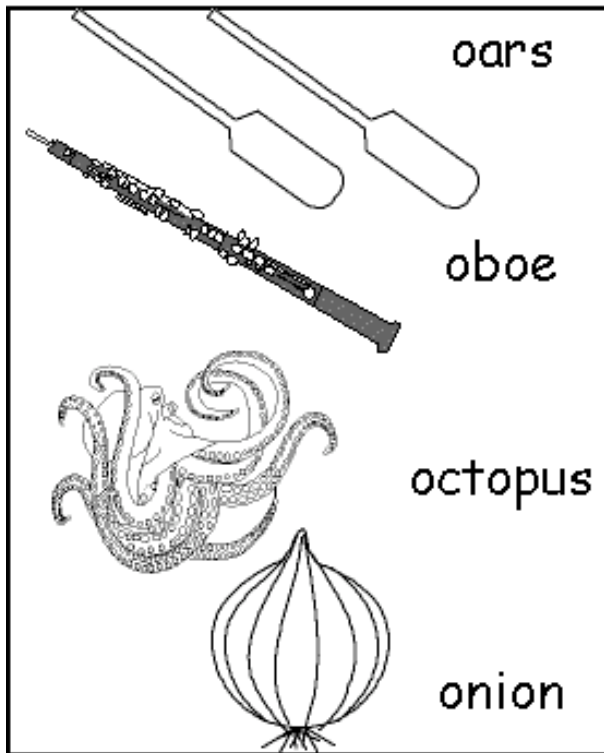



©EnchantedLearning.com



**Secret Words:**

Letter P Wordsearch. Name \_\_\_\_\_

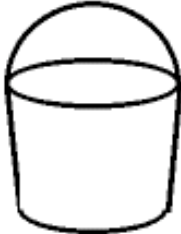
Circle the words that start with P.  
The extra letters spell two secret words!

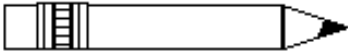
p	p	i	g	l	e	t	p
p	a	p	p	a	i	l	e
l	p	e	e	p	o	t	n
a	r	a	p	e	a	s	c
n	p	r	l	a	t	e	i
e	p	i	z	z	a	s	l

	pail
	pear
	peas
	pencil

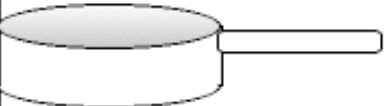
	piglet
	pizza
	plane
	pot

©EnchantedLearning.com



**Secret Words:**



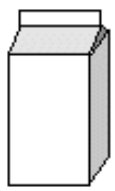

Letter Q Wordsearch. Name \_\_\_\_\_

Circle the words that start with Q.  
The extra letters make a secret word!

q	q	u	a	r	t	q	u
u	o	q	u	i	l	t	q
a	t	q	u	e	e	n	u
i	q	u	i	e	t	e	i
l	q	u	i	v	e	r	z
q	u	e	s	t	i	o	n

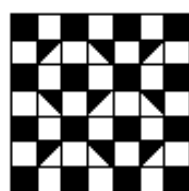
	quail
	quart
	queen
	question

	quiet
	quilt
	quiver
	quiz

©EnchantedLearning.com

**Secret Word:** \_\_\_\_\_

Letter R Wordsearch. Name \_\_\_\_\_

Circle the words that start with R.  
The extra letters spell a secret word!

r	r	a	i	n	b	o	w
o	r	a	b	b	i	t	r
b	a	r	o	s	e	i	r
o	l	r	r	a	t	o	a
t	a	r	i	n	g	d	k
r	a	c	c	o	o	n	e

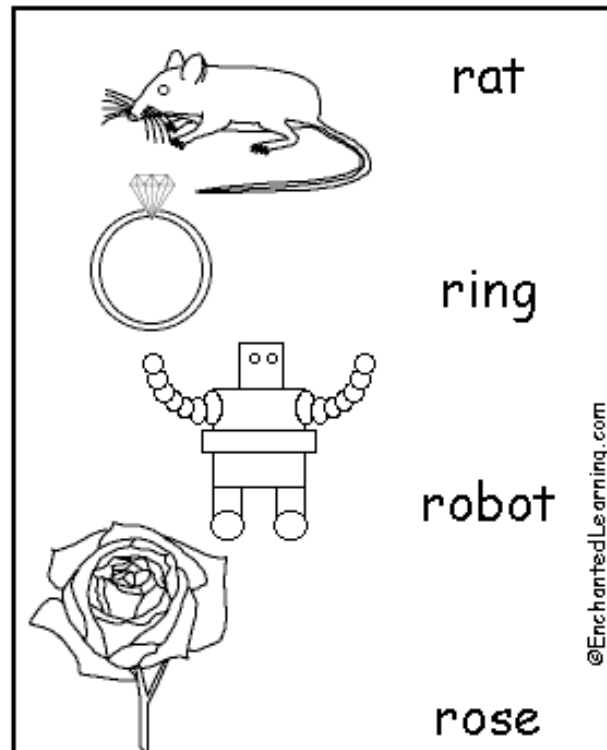
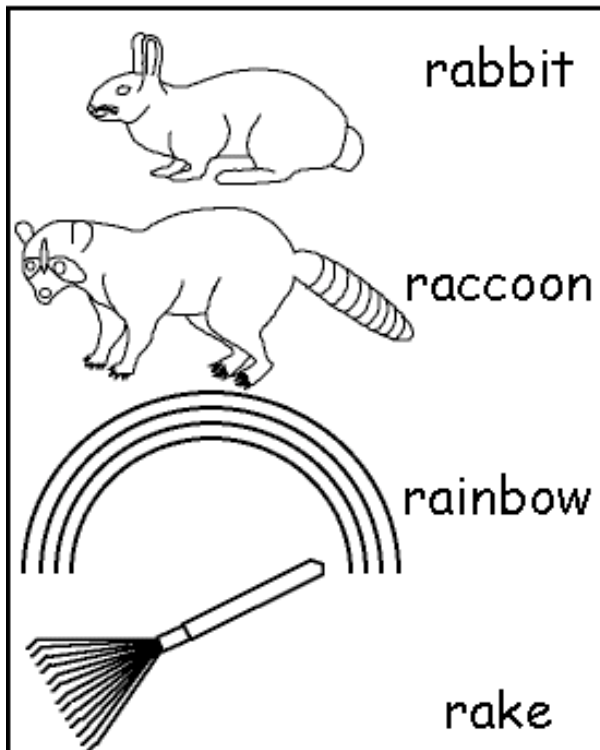





©EnchantedLearning.com



**Secret Word:**

Letter S Wordsearch. Name \_\_\_\_\_

Circle the words that start with S.  
The extra letters spell a secret word!

s	s	a	n	d	a	l	s
e	s	s	s	o	c	k	s
v	e	u	s	i	x	n	s
e	a	f	l	o	w	e	a
n	l	r	s	e	w	s	w
s	a	i	l	b	o	a	t

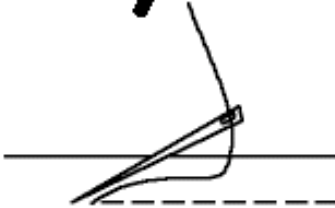
	sailboat
	sandals
	saw
	seal

7	seven
	sew
6	six
	socks





©EnchantedLearning.com



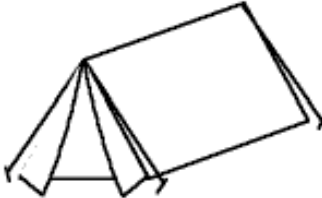

**Secret Word:** \_\_\_\_\_

Letter T Wordsearch. Name \_\_\_\_\_

Circle the words that start with T.  
The extra letters spell a secret word!

t	t	o	o	t	h	t	t
o	i	t	i	g	e	r	a
m	c	t	o	a	d	k	b
a	t	o	i	l	e	t	l
t	t	e	n	t	l	e	e
o	t	a	d	p	o	l	e

	table
	tadpole
	tent
	tiger

	toad
	toilet
	tomato
	tooth

©EnchantedLearning.com

**Secret Word:**

Letter U Wordsearch. Name \_\_\_\_\_

**Circle the words that start with U.  
The extra letters spell a secret word!**

u	n	i	f	o	r	m	s
u	n	i	c	y	c	l	e
u	u	n	u	p	d	e	r
s	u	n	h	a	p	p	y
a	u	n	i	c	o	r	n
u	m	b	r	e	l	l	a



umbrella

unhappy

unicorn

uniforms

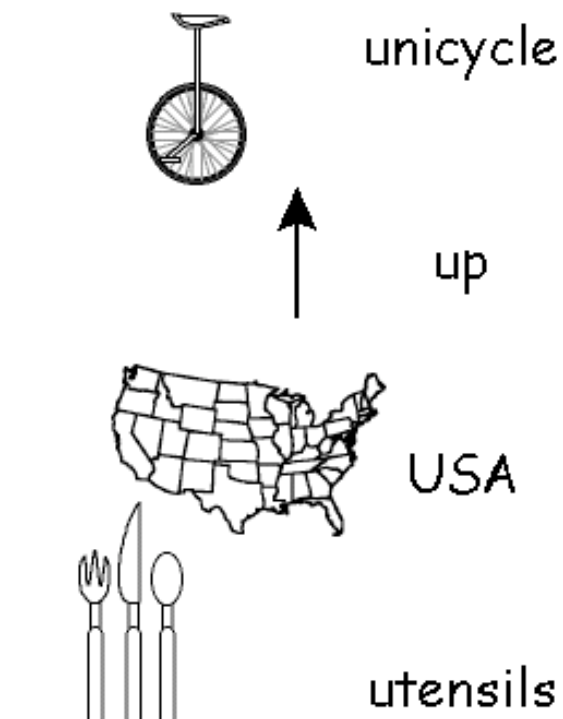

unicycle

up

USA

utensils



©EnchantedLearning.com



**Secret Word:**

Letter V Wordsearch. Name \_\_\_\_\_

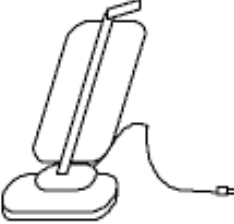
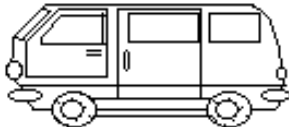
Circle the words that start with V.  
The extra letters spell a secret word!

v	v	o	w	e	l	s	v
v	a	v	e	s	t	c	a
o	a	t	v	a	n	i	c
t	o	v	a	t	n	s	u
e	v	i	o	l	i	n	u
v	u	l	t	u	r	e	m

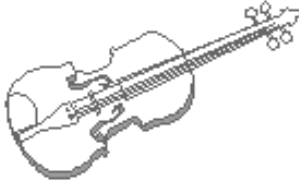
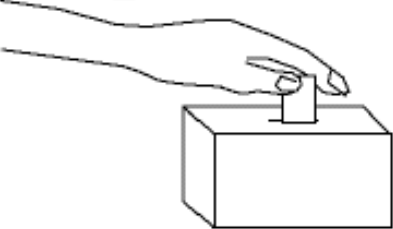
	vacuum
	van
	vat
	vest

	violin
	vote
a, e, i, o, u	vowels
	vulture

©EnchantedLearning.com

**Secret Word:** \_\_\_\_\_

Letter W Wordsearch. Name \_\_\_\_\_

**Circle the words that start with W.  
The extra letters spell a secret word!**

w	w	a	s	p	a	t	w
w	h	a	l	e	e	w	a
r	m	w	e	b	e	a	l
l	w	h	e	e	l	n	r
w	o	r	l	d	o	d	u
n	w	a	g	o	n	s	s

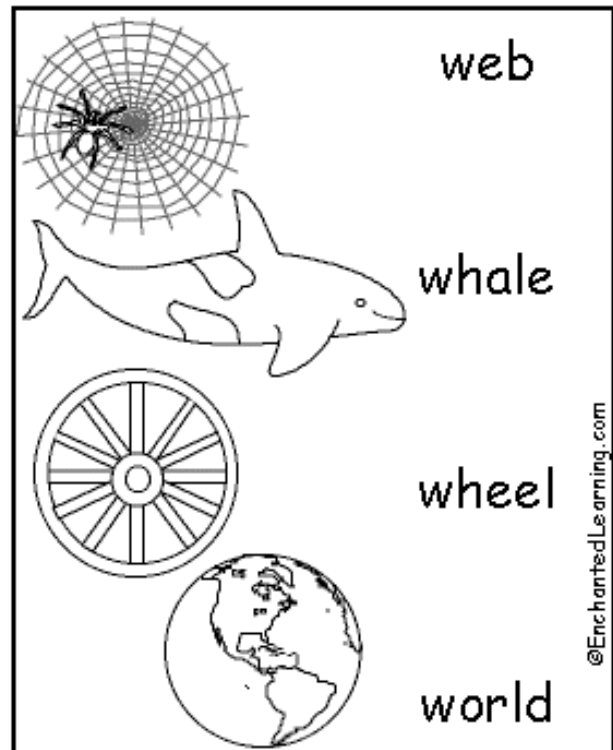
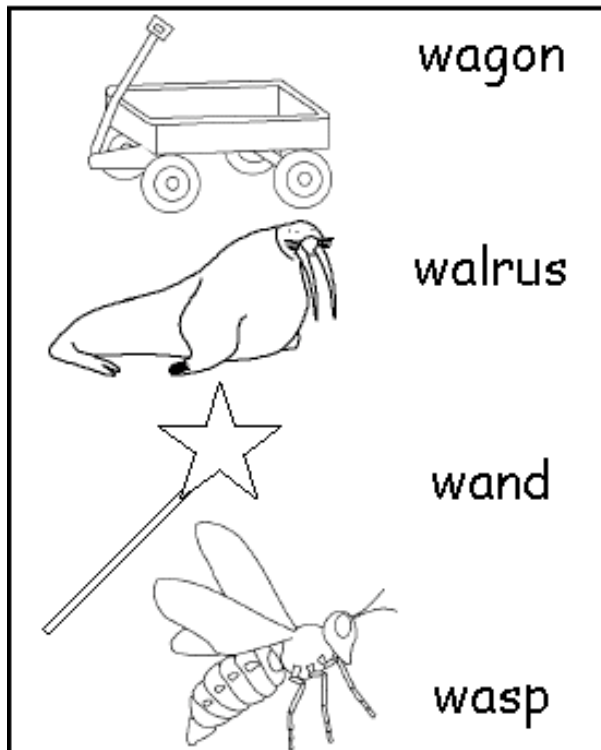



©EnchantedLearning.com



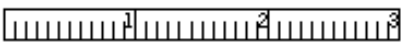
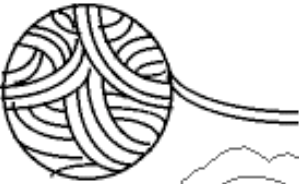

**Secret Word:**

Letter Y Wordsearch. Name \_\_\_\_\_

Circle the words that start with Y.  
The extra letters spell a secret word!

y	y	o	l	k	e	l	y
y	y	o	y	o	l	y	o
a	o	y	a	r	n	a	g
w	w	j	a	c	k	r	u
n	y	e	l	l	e	d	r
y	a	c	h	t	t	s	t

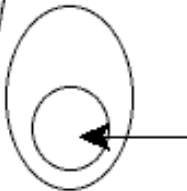
	yacht
	yard
	yarn
	yawn

	yell
	yogurt
	yolk
	yo-yo

©EnchantedLearning.com



**Secret Word:** \_\_\_\_\_





Letter Z Wordsearch. Name \_\_\_\_\_

Circle the words that start with Z.  
The extra letters spell a secret word!

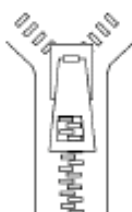
z	z	i	g	z	i	g	s
e	z	i	t	h	e	r	z
b	z	z	i	n	n	i	a
r	o	i	z	e	r	o	p
a	o	z	i	p	p	e	r
z	u	c	c	h	i	n	i

	zebra
	zero
	zig-zag
	zipper

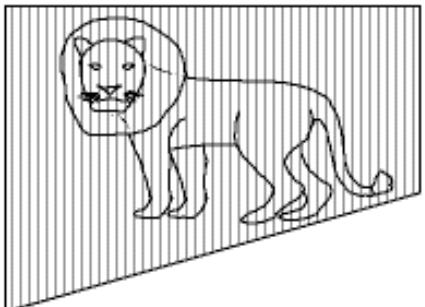
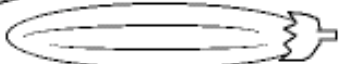
	zinnia
	zither
	zoo
	zucchini

©EnchantedLearning.com

**Secret Word:** \_\_\_\_\_